



Miscellaneous hangers

1 ADJUSTABLE HANGER.....		<i>pp.</i> 350
2 INTERLOCKING HANGER.....	 351
3 EXTRACTOR HOOD ADJUSTMENT PIVOT	 352

1 ADJUSTABLE HANGER

ADJUSTABLE HANGER.

			
ZINC-PLATED	655.500.031	500	

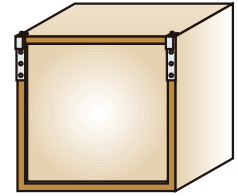
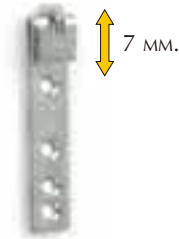

ADJUSTABLE CABINET HANGER.

	LEFT	RIGHT	
ZINC-PLATED	655.700.032	655.600.035	500

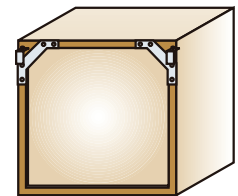

TWIN COUPLER WITH SIDE STOPS.

		
ZINC-PLATED	619.800.031	250

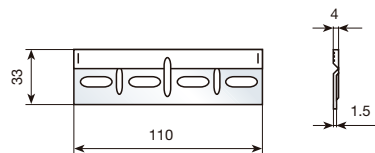

CABINET HANGER SUPPORT.

		
ZINC-PLATED	620.600.035	500

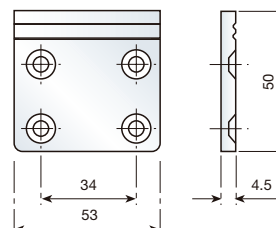

2 INTERLOCKING HANGER

THIS HANGER IS VERY HANDY FOR BATHROOM ACCESSORIES AND OTHER ELEMENTS WHERE HANGING IS NECESSARY, AND IS 100% CONCEALED.

HANGING SUPPORT.

ZINC-PLATED	621.700.030	2.000
-------------	-------------	-------

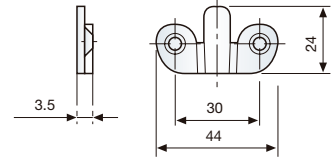

ASSEMBLY: PLACE THE SUPPORT ON THE WALL WITH THE HOOK FACING UPWARDS, AND ON THE SHELF WITH THE HOOK FACING DOWNWARDS. HANG THE SHELF BY INTERLOCKING THE TWO HOOKS. THE SUPPORTS WILL BE HELD TIGHTLY TOGETHER BY THE HOOKING SYSTEM.

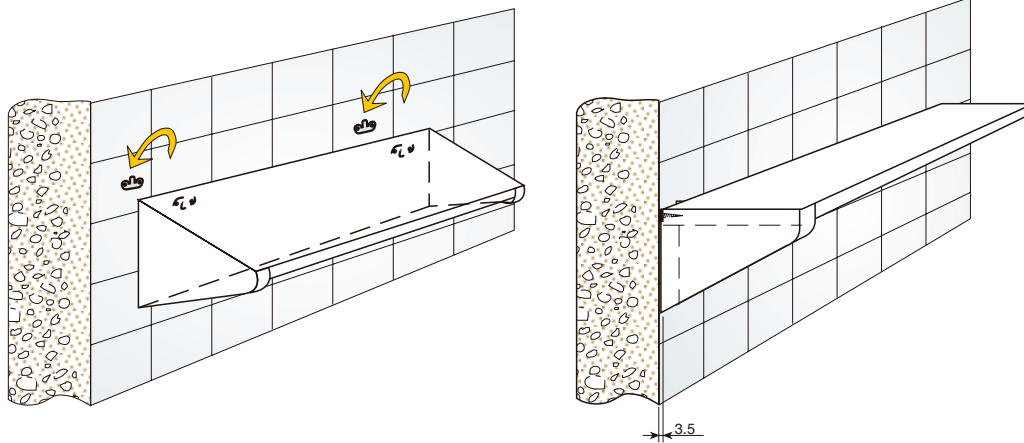

3 EXTRACTOR HOOD ADJUSTMENT PIVOT

EXTRACTOR HOOD ADJUSTMENT PIVOT.

				
WHITE	RAL 9001	610.000.005		500
BROWN	RAL 8016	610.000.016		

