



“SUPRA” drawer

“SUPRA” drawer

	<i>pp.</i>
1 “SUPRA-1” DRAWER	473
■ DRAWERS WITH WOODEN BACK	473
■ DRAWERS WITH STEEL BACK. QUICK ASSEMBLY	474
■ RUNNERS	475
■ FRONT COUPLER	476
■ PAN DRAWER ACCESSORIES	477
■ CUTLERY TRAY	478
■ TECHNICAL DATA	479
<hr/>	
2 “SUPRA-2” DRAWER	481
■ DRAWER SET	481

1 "SUPRA-1" DRAWER

DRAWERS WITH WOODEN BACK

"SUPRA 54" DRAWER

LOAD	L	WHITE RAL 9001	
250 N. (25 KP.)	270	653.027.001	100
	350	653.035.003	
	400	653.040.006	
	450	653.045.002	
	500	653.050.005	
	550	653.055.001	

REFERENCE CONSISTS OF TWO DRAWER SIDES, PACKED SEPARATELY IN BOXES OF 25 SIDES.

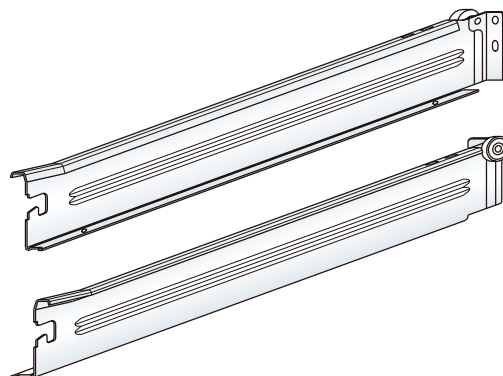

"SUPRA 86" DRAWER

LOAD	L	WHITE RAL 9001	GREY RAL 7040	
250 N. (25 KP.)	270	653.127.005		100
	350	653.135.000		
	400	653.140.003		
	450	653.145.006		
	500	653.150.002	653.150.315	
	550	653.155.005		

REFERENCE CONSISTS OF TWO DRAWER SIDES, PACKED SEPARATELY IN BOXES OF 25 SIDES.

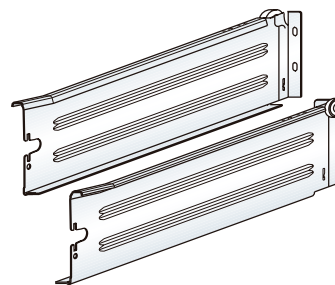

"SUPRA 118" DRAWER

LOAD	L	WHITE RAL 9001	
250 N. (25 KP.)	350	653.235.004	100
	400	653.240.000	
	450	653.245.003	
	500	653.250.006	
	550	653.255.002	

REFERENCE CONSISTS OF TWO DRAWER SIDES, PACKED SEPARATELY IN BOXES OF 25 SIDES.

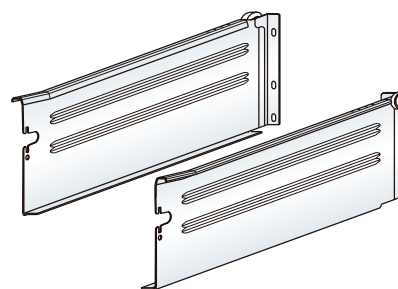

"SUPRA 150" DRAWER

LOAD	L	WHITE RAL 9001	GREY RAL 7040	
250 N. (25 KP.)	350	653.335.001		100
	400	653.340.004		
	450	653.345.000		
	500	653.350.003	653.350.316	
	550	653.355.006		

REFERENCE CONSISTS OF TWO DRAWER SIDES, PACKED SEPARATELY IN BOXES OF 25 SIDES.

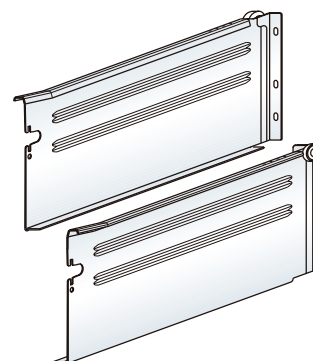

DRAWERS WITH STEEL BACK. QUICK ASSEMBLY

86 MM. STEEL BACK FOR "SUPRA 86" AND SUPRA- 86 "QUICK ASSEMBLY".

MODULE	WHITE RAL 9001	
300	654.030.005	25
350	654.035.001	
400	654.040.004	
450	654.045.000	
500	654.050.003	
600	654.060.002	
900	654.090.006	

MINIMUM ORDER: 100 BACKS.

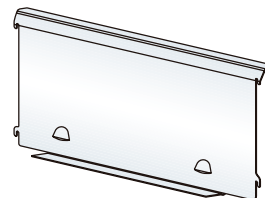
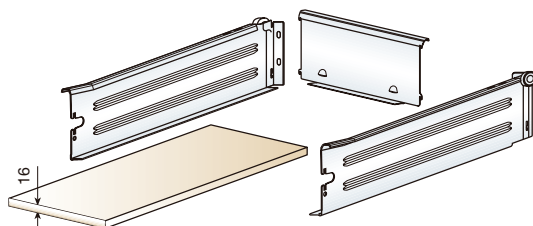

150 MM. STEEL BACK FOR "SUPRA 86" AND SUPRA- 86 "QUICK ASSEMBLY".

MODULE	WHITE RAL 9001	
300	654.130.002	25
350	654.135.005	
400	654.140.001	
450	654.145.004	
500	654.150.000	
600	654.160.006	
900	654.190.003	

MINIMUM ORDER: 100 BACKS.

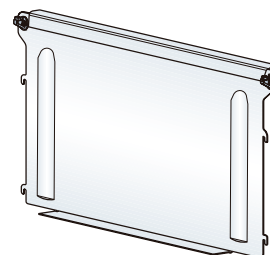
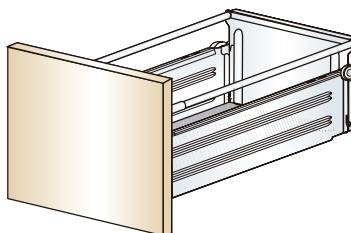

SUPRA- 86 "QUICK ASSEMBLY"

LOAD	L	WHITE RAL 9001	
250 N. (25 KP.)	270	653.127.005	100
	350	653.135.000	
	400	653.140.003	
	450	653.145.006	
	500	653.150.002	
	550	653.155.005	

EACH REFERENCE CONSISTS OF TWO DRAWER SIDES AND THE 2 PROFILES ARE PACKED SEPARATELY. THE SIDES COME IN BOXES OF 25 UNITS.

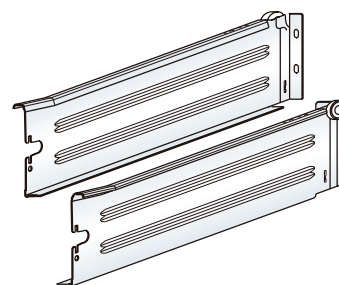

RUNNERS

"GACELA" RUNNER

DRAWER LENGTH	EXTENSION LOSS P.S.	WHITE RAL 9001	
270	52	653.427.003	100
350	61	653.435.005	
400	70	653.440.001	
450	79	653.445.004	
500	88	653.450.000	
550	97	653.455.003	

REFERENCE CONSISTS OF A COMPLETE SET OF RUNNERS, PACKED SEPARATELY IN BOXES OF 100 RUNNERS.

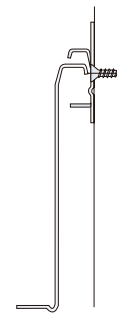
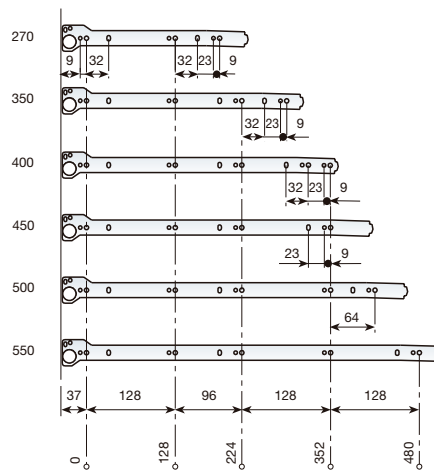
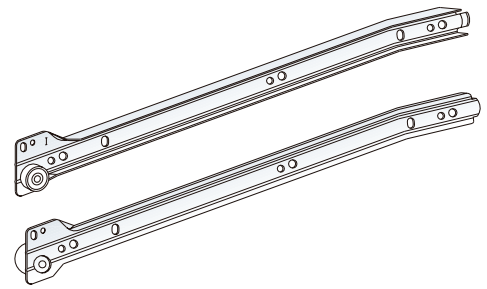

"GACELA" RUNNER

FULL EXTENSION "GACELA" RUNNER

DRAWER LENGTH	EXTENSION LOSS P.S.	WHITE RAL 9001	
270	0	653.727.001	100
350	0	653.735.003	
400	0	653.740.006	
450	0	653.745.002	
500	0	653.750.005	
550	0	653.755.001	

REFERENCE CONSISTS OF 2 S-PROFILES AND 2 U-PROFILES. U-PROFILES ARE PACKED SEPARATELY IN BOXES OF 100 RUNNERS AND S-PROFILES ARE PACKED SEPARATELY IN BOXES OF 50 RUNNERS.

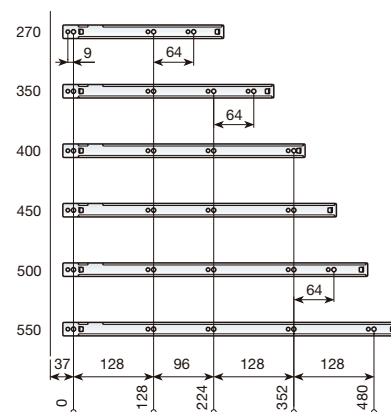
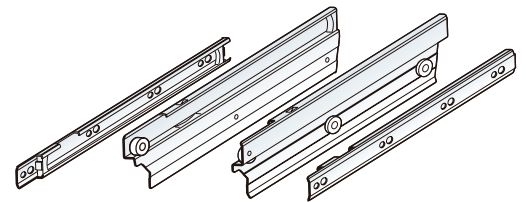

"GACELA"
RUNNER

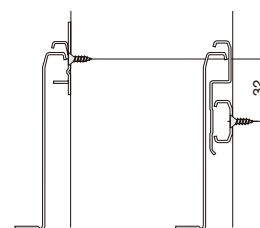

TELESCOPIC
"GACELA" RUNNER

FRONT COUPLER

PLASTIC FRONT COUPLER FOR "SUPRA 54" DRAWER.

			
WHITE	RAL 9001 c/32 MM.	676.905.003	100

EACH REFERENCE CONSISTS OF A COMPLETE SET OF COUPLERS
LATERAL ADJUSTMENT 3 MM. HEIGHT ADJUSTMENT 3 MM.

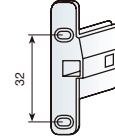

STEEL FRONT COUPLERS FOR "SUPRA 86", "SUPRA 118" AND "SUPRA 150" DRAWERS.

	NICKEL-PLATED	WHITE RAL9001	
	679.300.064	677.900.005	100

EACH REFERENCE CONSISTS OF A COMPLETE SET OF COUPLERS.
LATERAL ADJUSTMENT 3 MM. HEIGHT ADJUSTMENT 4 MM WITH NO TOOLS REQUIRED.

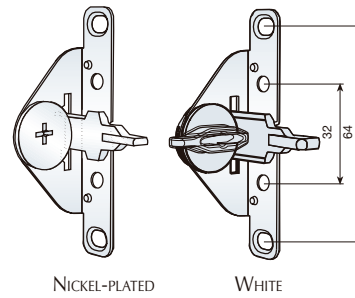

NICKEL-PLATED

WHITE

COVER.

			
WHITE	RAL 9001	654.900.002	100

EACH REFERENCE CONSISTS OF A COMPLETE SET OF COVERS.

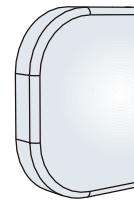

COVER

FRONT COUPLER FOR "SUPRA 86" INNER DRAWER.

			
WHITE	RAL 9001	676.911.001	100

EACH REFERENCE CONSISTS OF A COMPLETE SET OF COUPLERS.

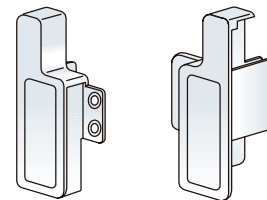

PAN DRAWER ACCESSORIES

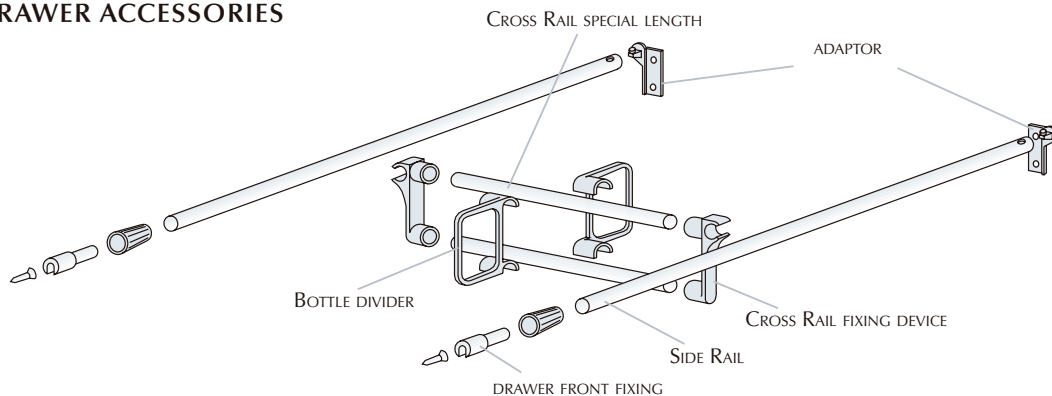

SIDE RAIL FOR 16MM DRAWER SIDE

MODULE	WHITE RAL 9001	
400	746.840.006	
450	746.845.002	
500	746.850.005	50
600	746.860.004	
900	746.890.001	

ADAPTOR.

	WHITE RAL 9001	
NICKEL-PLATED	733.000.063	50

REFERENCE CONSISTS OF A COMPLETE SET OF ADAPTORS.

CROSS RAIL FIXING DEVICE

	WHITE RAL 9001	
WHITE RAL 9001	732.400.001	100

SIDE RAIL

DRAWER LENGTH	WHITE RAL 9001	
400	746.640.005	
450	746.645.001	50
500	746.650.004	

BOTTLE DIVIDER

	WHITE RAL 9001	
WHITE RAL 9001	748.100.006	50

DRAWER FRONT FIXING

	WHITE RAL 9001	
WHITE RAL 9001	730.700.003	50

REFERENCE CONSISTS OF A COMPLETE SET OF COUPLERS.

CROSS RAIL, SPECIAL LENGTH

	WHITE RAL 9001	
WHITE RAL 9001	746.700.006	50

MI = INTERIOR MEASUREMENT OF THE FURNITURE. L = MI - 48 MM.

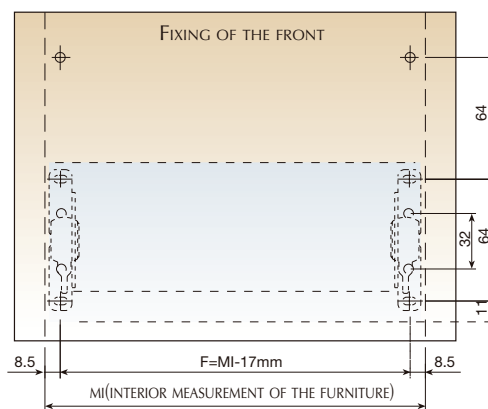
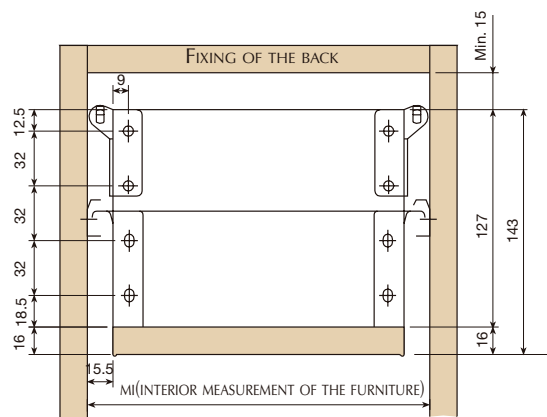

CUTLERY TRAY

CUTLERY TRAY, WHITE RAL-9001

MODULE	LENGTH 500	LENGTH 450	
300	678.130.003	678.330.004	
350	678.135.006	678.335.000	
400	678.140.002	678.340.003	20
450	678.145.005	678.345.006	
500	678.150.001	678.350.002	
600	678.160.000	678.360.001	



THESE MODULE DIMENSIONS ARE FOR 16 MM. SIDES, 450 AND 500 MM DRAWER SIZES AND 16 MM. BACK.

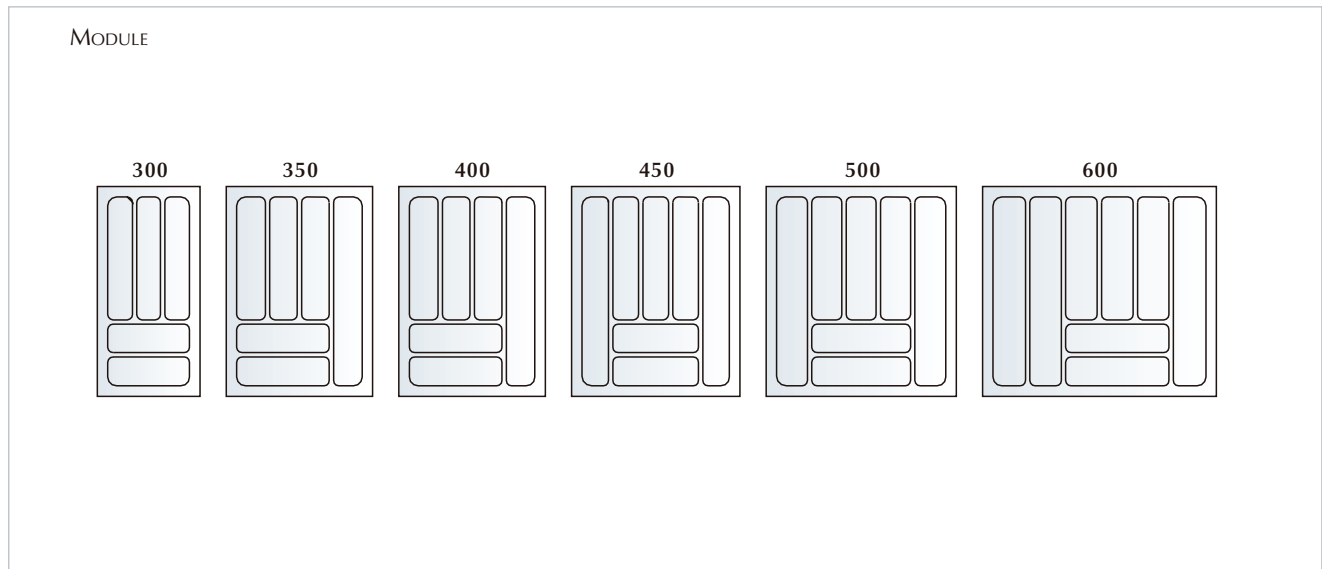

TECHNICAL DATA

CALCULATION OF THE BASE

CALCULATION OF THE BACK

L= LENGTH OF THE DRAWER

	SUPRA-54	SUPRA-86	SUPRA METAL BACK	SUPRA-118	SUPRA-150	SUPRA-86 C INT.
H	36	68	-	100	132	68
A	L-2	L-2	L-5	L-2	L-2	L-18

Adjustable steel front coupler for SUPRA- 86- 118- 150

“SUPRA-54”

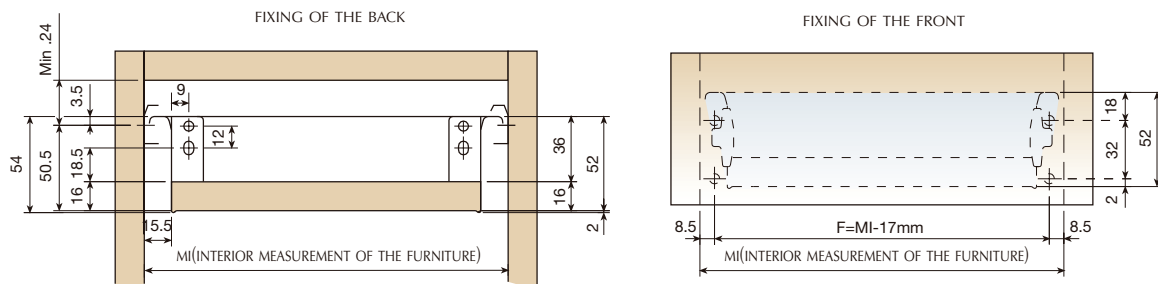

“SUPRA-86”, inner drawer

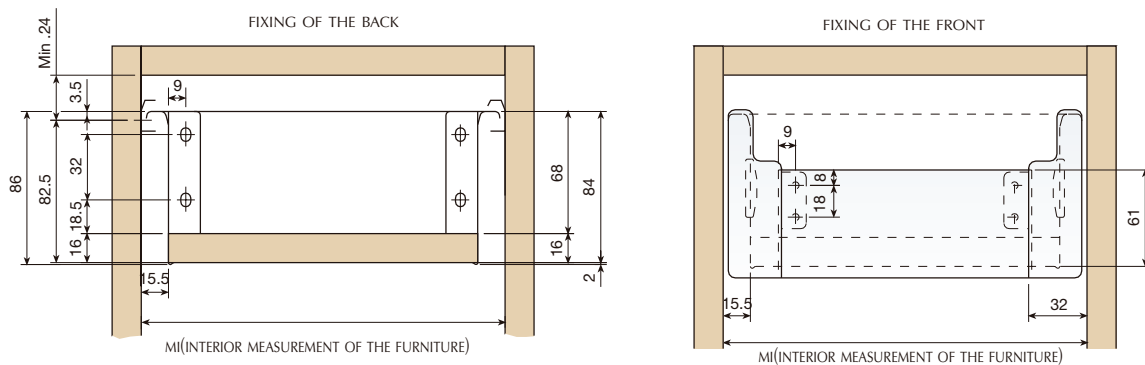

■ TECHNICAL DATA

“SUPRA-86”

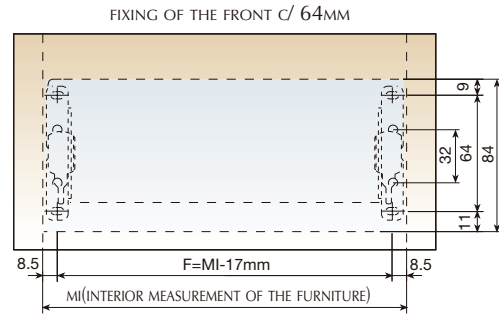
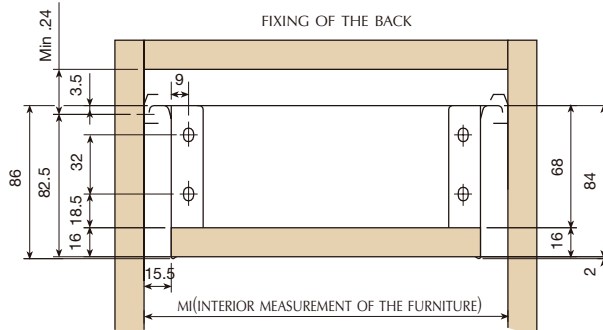

“SUPRA-118”

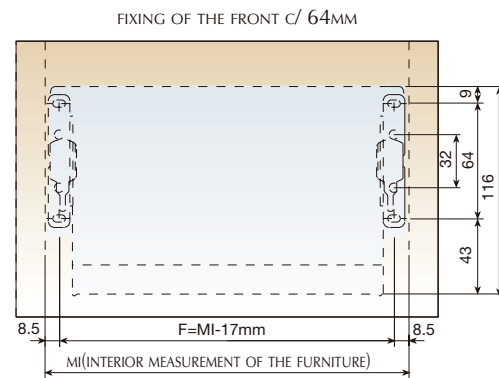
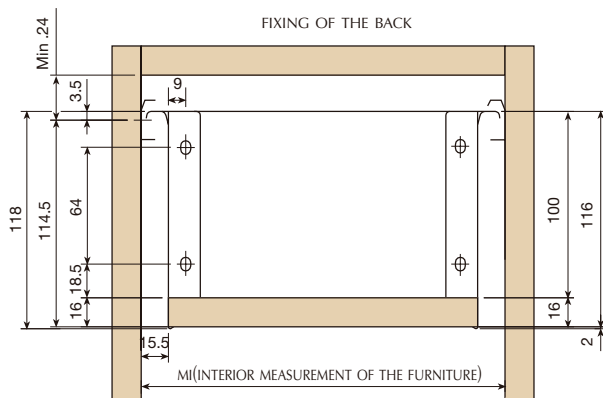

“SUPRA-150”

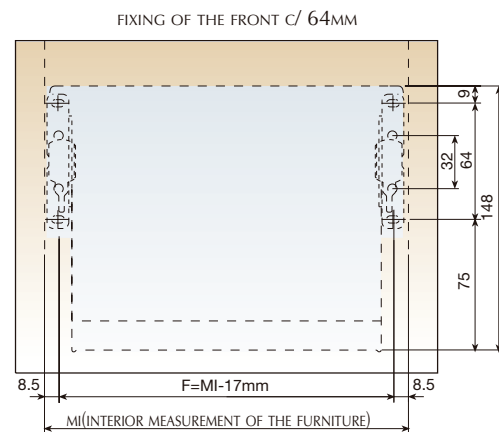
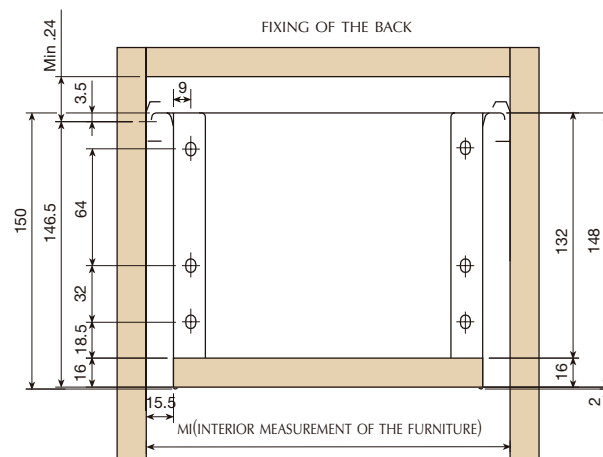

2 "SUPRA-2" DRAWER

DRAWER SET

MINIMUM ORDER: 100 SETS PER REFERENCE.

"SUPRA-2" 86.

MODULE	WHITE RAL 9001	
270	652.027.003	
400	652.040.001	
450	652.045.004	10
500	652.050.000	

EACH REFERENCE CONSISTS OF 1 SET OF STEEL FRONT COUPLER, 1 SET OF RUNNERS AND 1 SET OF DRAWER SIDES.

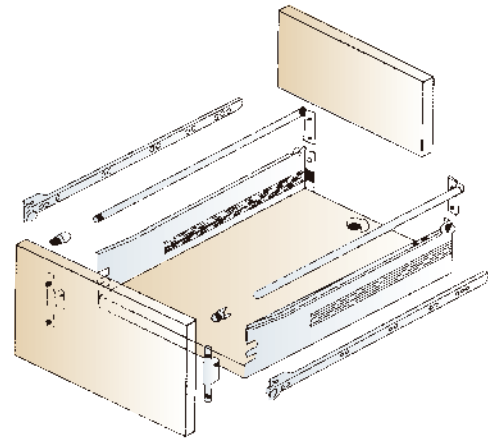

"SUPRA-2" 118.

MODULE	WHITE RAL 9001	
400	652.140.005	
450	652.145.001	10
500	652.150.004	

EACH REFERENCE CONSISTS OF 1 SET OF STEEL FRONT COUPLER, 1 SET OF RUNNERS AND 1 SET OF DRAWER SIDES.

"SUPRA-2" 150.

MODULE	WHITE RAL 9001	
400	652.240.002	
450	652.245.005	10
500	652.250.001	

EACH REFERENCE CONSISTS OF 1 SET OF STEEL FRONT COUPLER, 1 SET OF RUNNERS AND 1 SET OF DRAWER SIDES.

SIDE RAIL SET "SUPRA-2".

MODULE	WHITE RAL 9001	
400	652.340.006	
450	652.345.002	50
500	652.350.005	

