

# Dampers

**INDA**matic  
gradual closing

# Dampers

**INDA**matic  
gradual closing

		<i>pp.</i>
<b>1</b>	<b>INDEPENDENT DAMPERS</b> .....	39
■	EMBEDDED .....	39
■	LAY-ON .....	39
<hr/>		
<b>2</b>	<b>DAMPERS FOR “MESUCO” HINGES</b> .....	39
■	FOR CUP .....	39



## 1 INDEPENDENT DAMPERS

### EMBEDDED

INDAMATIC DAMPER.

				
WHITE	RAL 9001	213.400.003		
BLACK	RAL 9005	213.400.025	100	
GREY	RAL 7040	213.400.316		

**INDA**matic  
gradual closing

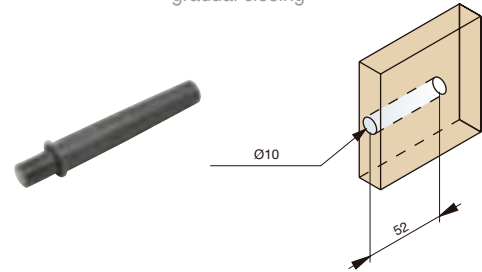

### LAY-ON

BASE PLATE S/32 FOR DAMPER.

				
WHITE	RAL 9001	213.500.000		
BLACK	RAL 9005	213.500.022	100	
GREY	RAL 7040	213.500.313		

REVERSIBLE BASE PLATE: THIS BASE PLATE IS VALID FOR POSITIONING THE FIRST DRILL AT 28 OR 37 MM.

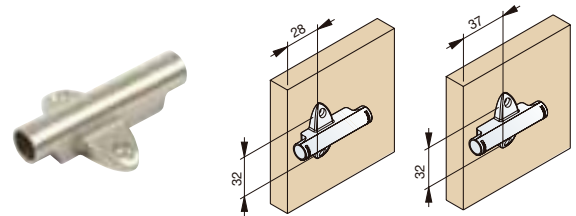

BODY AND BASE PLATE FOR DAMPER.

				
WHITE	RAL 9001	213.600.004		
BLACK	RAL 9005	213.600.026	100	
GREY	RAL 7040	213.600.310		

EVERY REF. HAS 1 BODY AND 1 BASE PLATE.

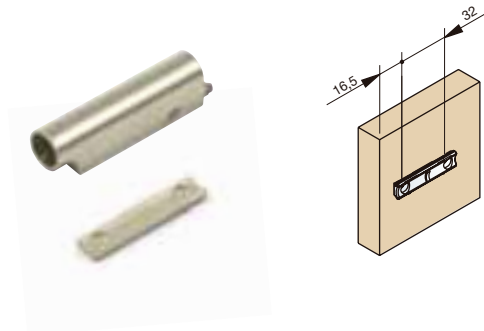

## 2 DAMPERS FOR "MESUCO" HINGES

### FOR CUP

INDAMATIC FOR "MESUCO 413" HINGE CUP.

				
NIQUEL-PLATED PLASTIC		197.801.063		
NIQUEL-PLATED ZAMAK		197.802.065	125	

**INDA**matic  
gradual closing

